

NEXUS KERNELS
Milan/Italy 2024

PRESENTED BY
Arco Blu Atelier

Arco Blu

Atelier

The Nexus Kernels table is a symbol of adaptability and a representation of natural communication. Acting as a catalyst for communication and facilitating human relationships, it easily adapts to various settings where friends and family gather, such as dynamic office environments or serene studios, to meet the unique needs and desires of its users.

The outer structure of the Nexus table is organic, orderly, and soft with three branches at three different angles, resembling a platform that houses a kernel at its core. When placed next to another Nexus Kernels table, they can elegantly come close to each other and create a new shape. Its core is a vibrant red kernel that radiates warmth and vitality. However, this central kernel is more than an enticing focal point; it holds a hidden function within itself. By removing the kernel and rotating it 180 degrees, the core beautifully transforms into a suitable base for a fragrance diffuser, and by placing a flower branch inside the core essence, the wick becomes moist and transfers scent to the petals, gently perfuming the environment. Considering that the red kernel brings forth the secrets of nature, like a pulsating heart of the table, it symbolizes unity and an inherent power that emanates from within.

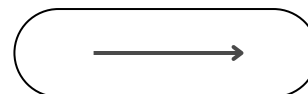

NEXUS KERNELS
Milan/Italy 2024

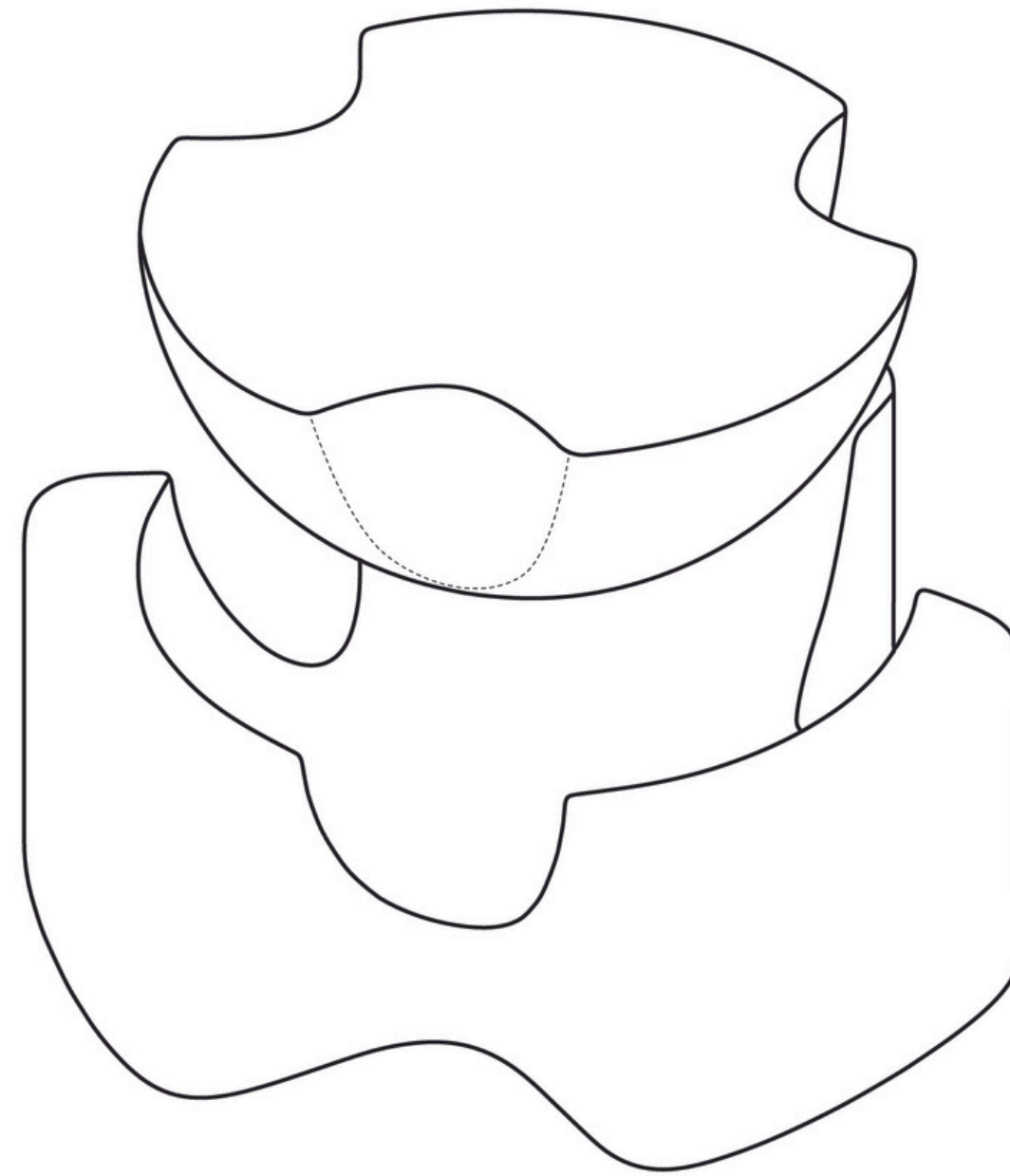
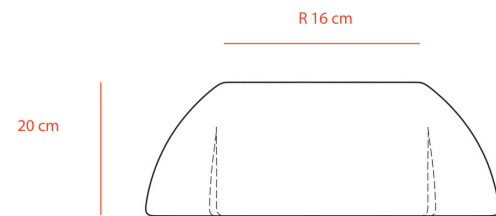
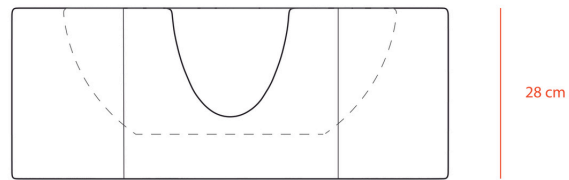
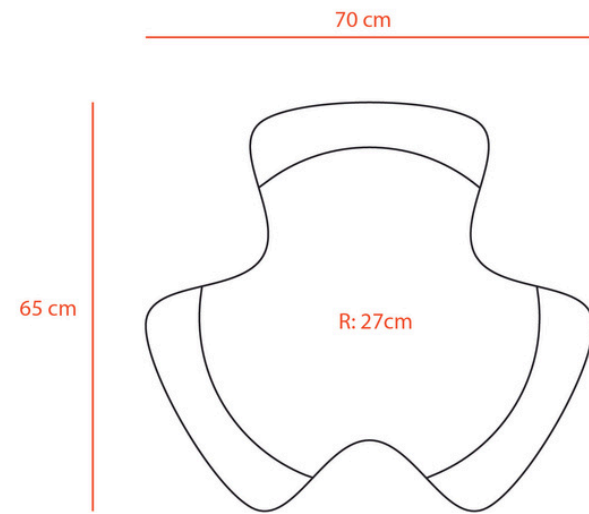

MATERIALS



Nero Marquinia Unito

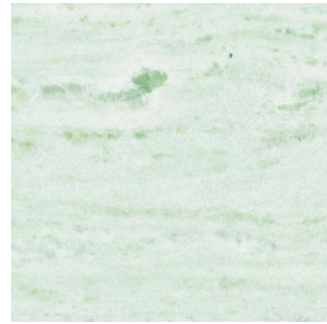

Pinta Verde



Oak Gray

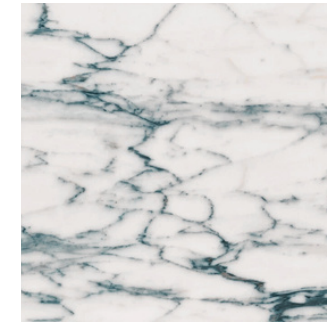

Arabescato Carrara

MARBLE

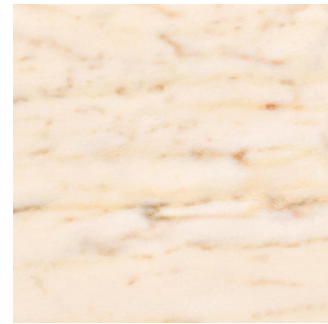

Rosa Portogallo



Calacatta Macchia Vecchia



Calacatta Oro

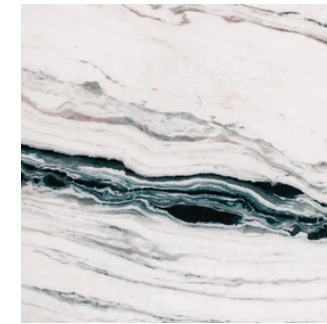

Panda White

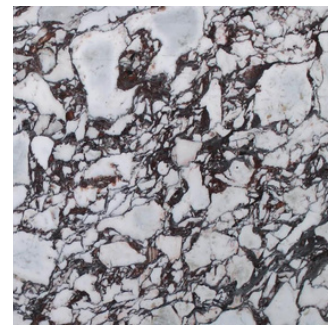

Calacatta Viola

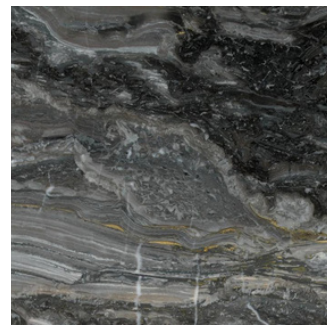

Arabescato Grigio Orobico

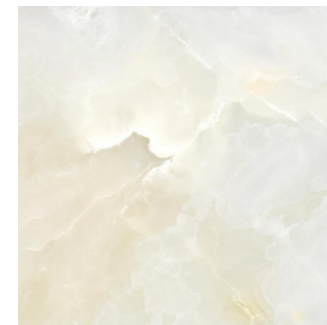

Onice Bianco



Onice Rosa

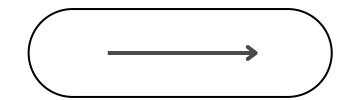

NEXUS KERNELS
Milan/Italy 2024

MATERIALS

METAL

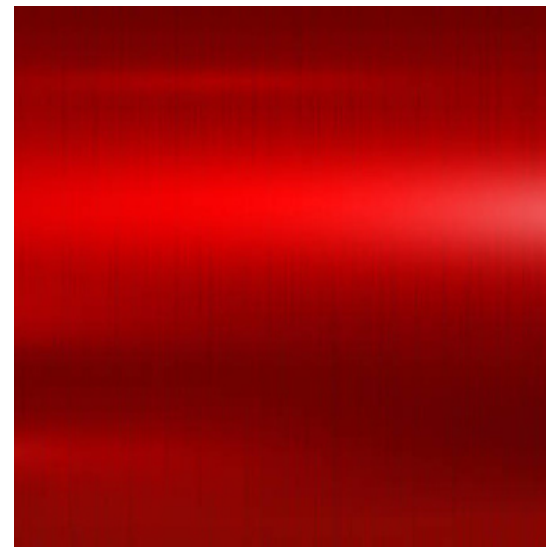

Red Aluminun

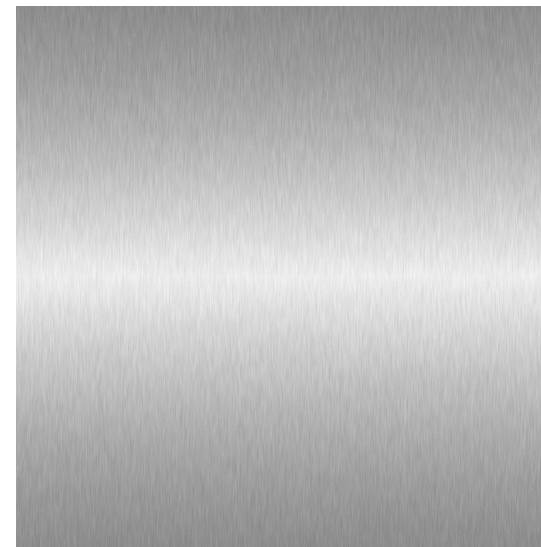

Silver Aluminun



Gold Aluminun

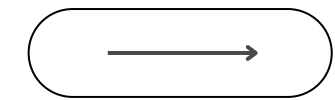



ArcoBlu *Atelier*

All Rights Reserved Arcoblu Atelier_2024